

## SiC SBD P3D12005K2

### 1200V SiC Schottky Diode

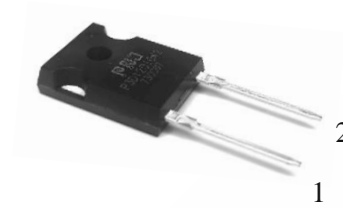

### Features

- Ultra-Fast Switching
- Zero Reverse Recovery Current
- High-Frequency Operation
- Positive Temperature Coefficient on  $V_F$
- High Surge Current
- 100% UIS tested

TO-247-2

Cathode	1
Anode	2



### Standards Benefits

- Improve System Efficiency
- Reduction of Heat Sink Requirement
- Essentially No Switching Losses
- Parallel Devices Without Thermal Runaway



### Application

- Consumer SMPS
- Boost Diodes in PFC or DC/DC Stages
- AC/DC Converters



### Order Information

Part Number	Package	Marking
P3D12005K2	TO-247-2	P3D12005K2



## Contents

Features.....	1
Standards Benefits .....	1
Application.....	1
Order Information .....	1
<b>Contents.....</b>	<b>2</b>
1. Maximum Ratings.....	3
2. Thermal Characteristics.....	3
3. Electrical Characteristics .....	4
4. Typical Performance .....	5
5. Package Outlines.....	6

PN Junction Semiconductor

## 1. Maximum Ratings

At  $T_J = 25^\circ\text{C}$ , unless specified otherwise

Parameter	Symbol	Value	Unit	Test condition
Repetitive Peak Reverse Voltage	$V_{RRM}$	1200	V	$T_C = 25^\circ\text{C}$
Surge Peak Reverse Voltage	$V_{RSM}$	1200	V	$T_C = 25^\circ\text{C}$
DC Blocking Voltage	$V_R$	1200	V	$T_C = 25^\circ\text{C}$
Forward Current	$I_F$	23 10 5	A	$T_C = 25^\circ\text{C}$ $T_C = 125^\circ\text{C}$ $T_C = 160^\circ\text{C}$
Repetitive Peak Forward Surge Current	$I_{FRM}$	25 18	A	$T_C = 25^\circ\text{C}, t_p = 10\text{ms}$ $T_C = 125^\circ\text{C}, t_p = 10\text{ms}$
Non-Repetitive Forward Surge Current	$I_{FSM}$	55 50	A	$T_C = 25^\circ\text{C}, t_p = 10\text{ms}$ $T_C = 125^\circ\text{C}, t_p = 10\text{ms}$
Power Dissipation	$P_{tot}$	132	W	$T_C = 25^\circ\text{C}$
Operating Junction and Storage Temperature	$T_J, T_{STG}$	-55 to +175	$^\circ\text{C}$	
TO-247 Mounting Torque M3 Screw	$T_{torq}$	1 8.8	Nm lbf-in	

## 2. Thermal Characteristics

Parameter	Symbol	Values	Unit
Thermal Resistance from Junction to Case	$R_{\theta JC}$	1.14	$^\circ\text{C}/\text{W}$

### 3. Electrical Characteristics

At  $T_J = 25^\circ\text{C}$ , unless specified otherwise

Parameter	Symbol	Values			Unit	Test condition
		Min.	Typ.	Max.		
Forward Voltage	$V_F$	/	1.5	1.8	V	$I_F = 5\text{A}, T_J = 25^\circ\text{C}$
			2.1	/		$I_F = 5\text{A}, T_J = 175^\circ\text{C}$
Reverse Current	$I_R$	/	1.73	44	$\mu\text{A}$	$V_R = 1200\text{V}, T_J = 25^\circ\text{C}$
			149	/		$V_R = 1200\text{V}, T_J = 175^\circ\text{C}$
Total Capacitance	C	/	304	/	$\text{pF}$	$V_R = 0\text{V}, T_J = 25^\circ\text{C}$ $f = 1\text{MHz}$
			39			$V_R = 400\text{V}, T_J = 25^\circ\text{C}$ $f = 1\text{MHz}$
			37			$V_R = 800\text{V}, T_J = 25^\circ\text{C}$ $f = 1\text{MHz}$
Total Capacitive Charge	$Q_C$	/	36.8	/	nC	$V_R = 800\text{V}, I_F = 5\text{A}$ $di/dt = 200\text{A}/\mu\text{s}$ $T_J = 25^\circ\text{C}$
Capacitance Stored Energy	$E_C$	/	11.9	/	$\mu\text{J}$	$V_R = 800\text{V}$

## 4. Typical Performance

At  $T_J = 25^\circ\text{C}$ , unless specified otherwise

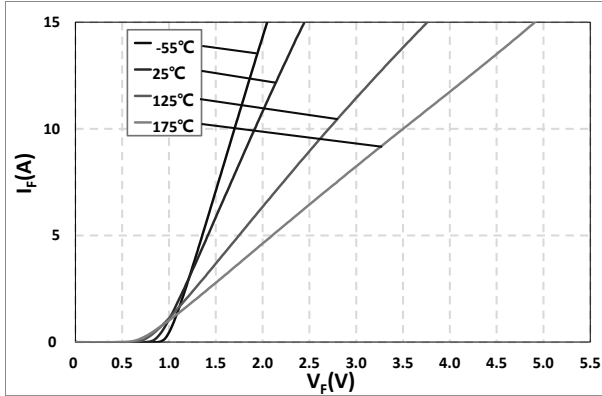

Fig. 1 Typical Forward Characteristics  
 $I_F = f(V_F)$ ;  $T_J = -55^\circ\text{C}, 25^\circ\text{C}, 125^\circ\text{C}, 175^\circ\text{C}$

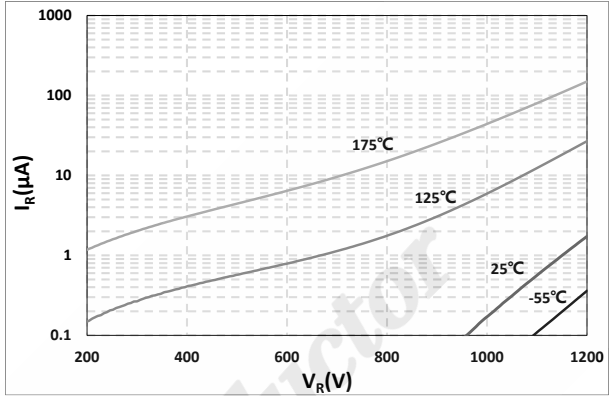

Fig. 2 Reverse Characteristics  
 $I_R = f(V_R)$ ;  $T_J = -55^\circ\text{C}, 25^\circ\text{C}, 125^\circ\text{C}, 175^\circ\text{C}$

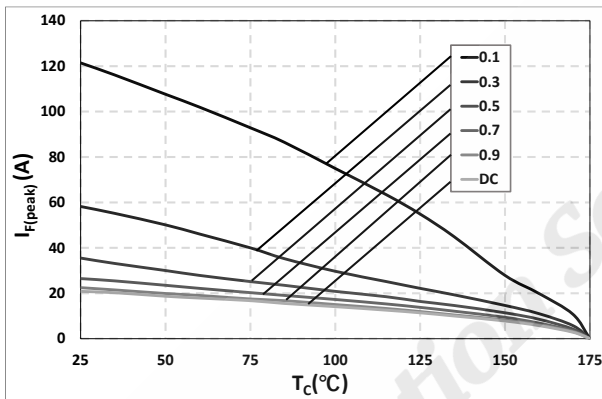

Fig. 3 Current Derating

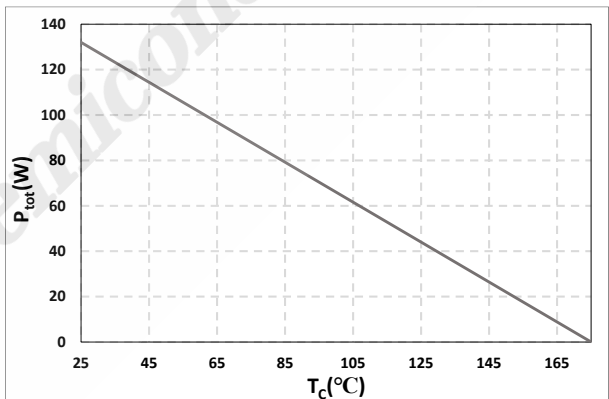

Fig. 4 Typical Power Derating  
 $P_{tot} = f(T_C)$

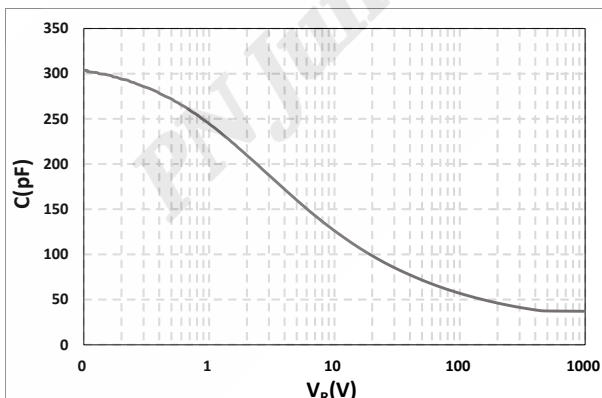

Fig. 5 Typical Total Capacitance  
 $C = f(V_R)$

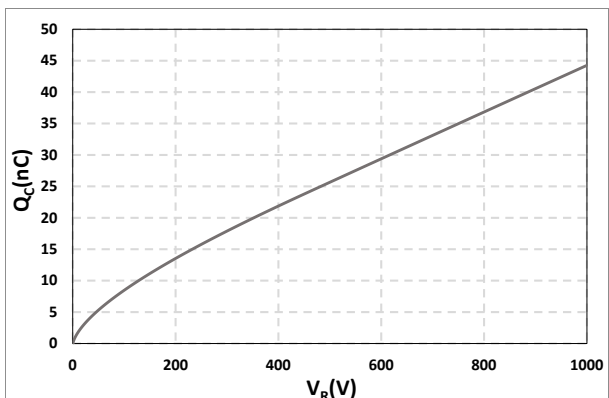

Fig. 6 Typical Total Capacitive Charge  
 $Q_C = f(V_R)$

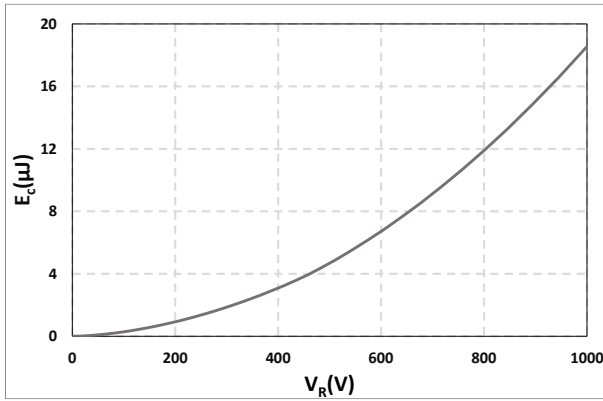

Fig. 7 Capacitance Stored Energy  
 $E_C = f(V_R)$

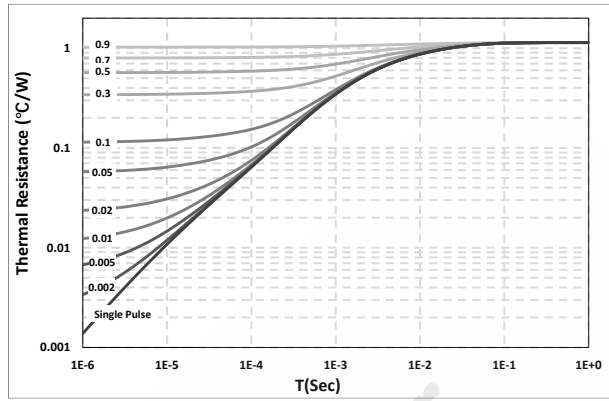
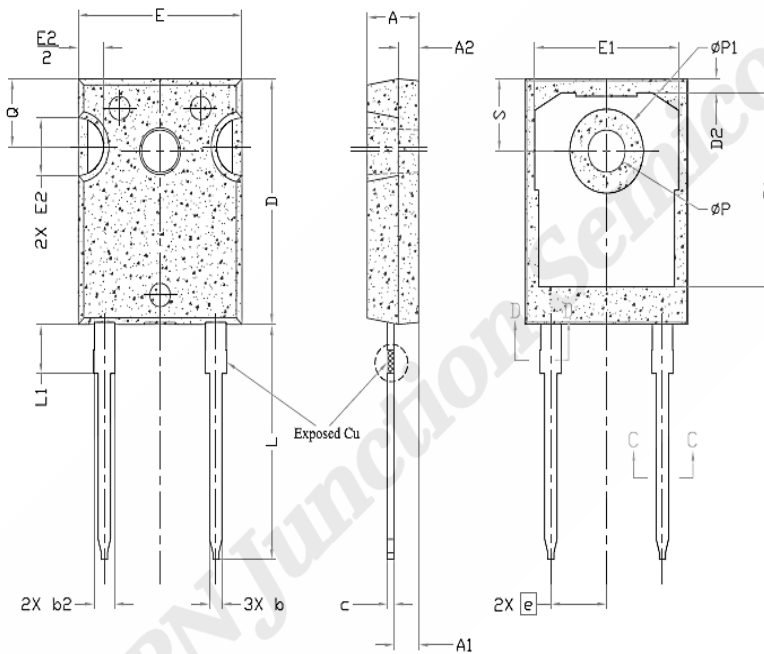

Fig. 8 Transient Thermal Impedance

## 5. Package Outlines



SYMBOL	DIMENSIONS			NOTES
	MIN.	NOM.	MAX.	
A	4.83	5.02	5.21	
A1	2.29	2.41	2.55	
A2	1.50	2.00	2.49	
b	1.12	1.20	1.33	
b1	1.12	1.20	1.28	
b2	1.91	2.00	2.39	6
b3	1.91	2.00	2.34	
c	0.55	0.60	0.69	6
c1	0.55	0.60	0.65	
D	20.80	20.95	21.10	4
D1	16.25	16.55	17.65	5
D2	0.51	1.19	1.35	
E	15.75	15.94	16.13	4
E1	13.46	14.02	14.16	5
E2	4.32	4.91	5.49	3
e	5.41BSC			
L	19.81	20.07	20.32	
L1	4.10	4.19	4.40	6
∅P	3.56	3.61	3.65	7
∅P1	7.19REF.			
Q	5.39	5.79	6.20	
S	6.04	6.17	6.30	

Drawing and dimensions